

Water Utility Field Operations

Water Repair

North

West

East

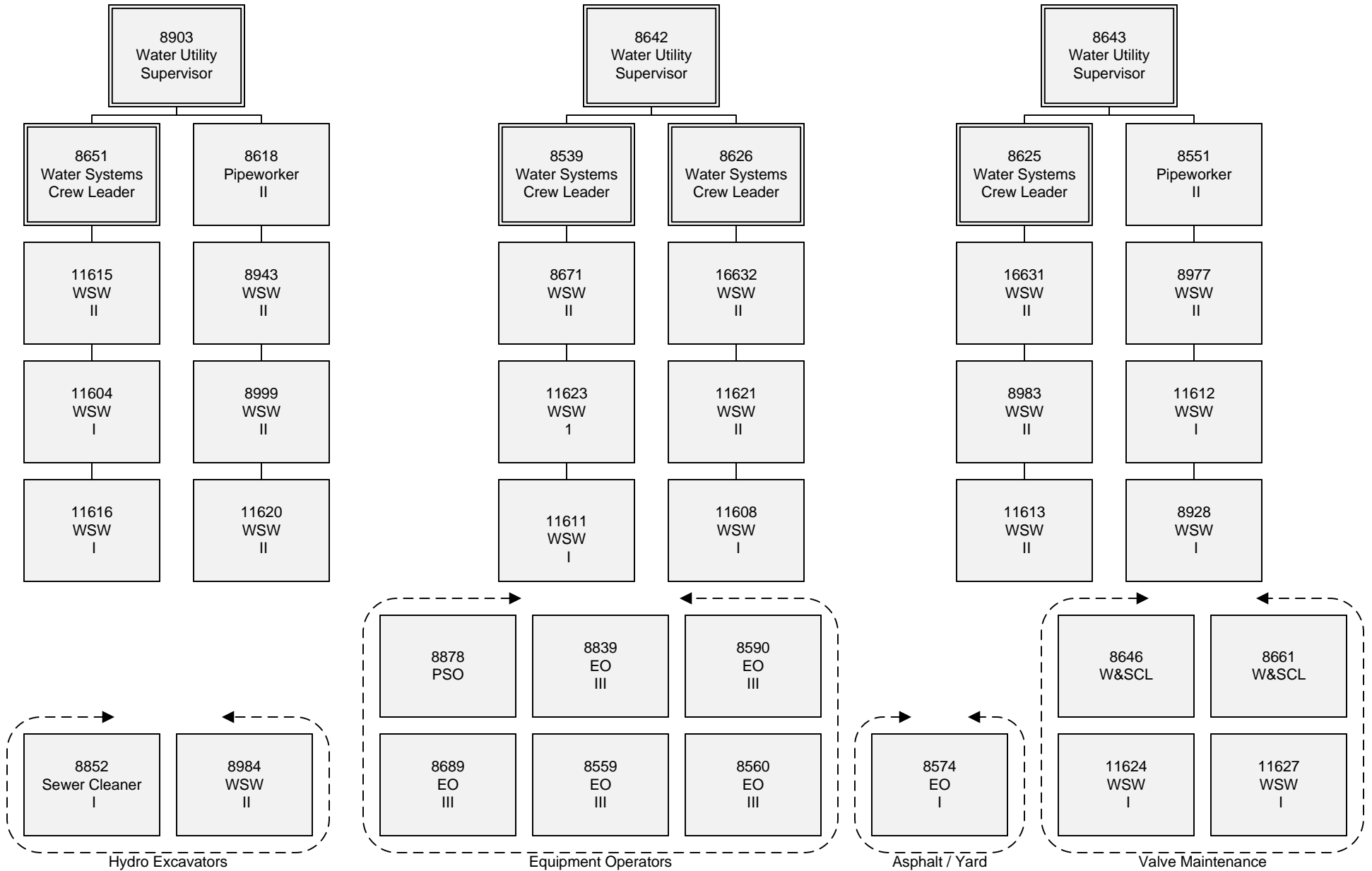

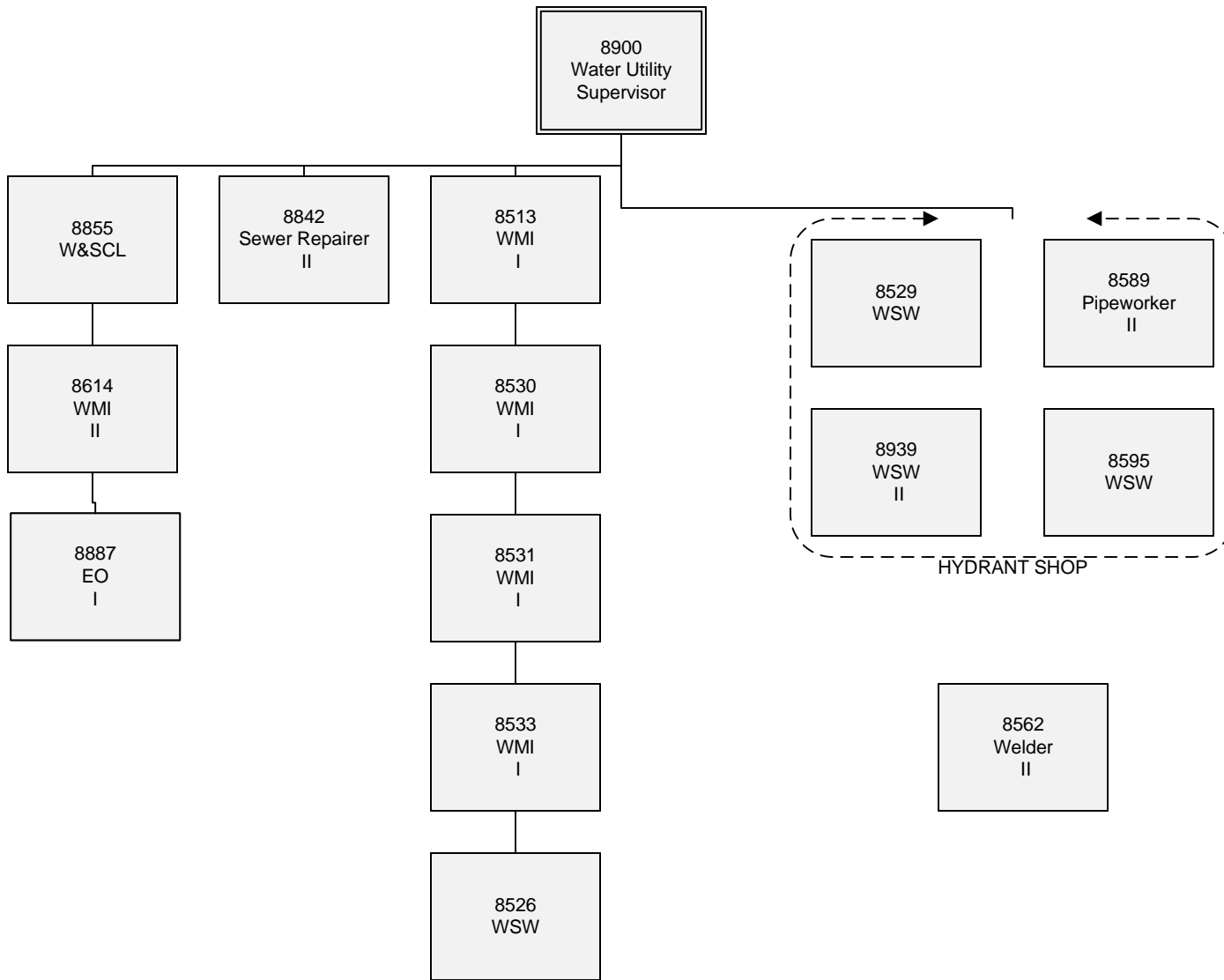

Hydrant/Meter Shop

8902
Water Utility
Supervisor

8656
W&SCL

8482
W&SCL

8997
W&SCL

8934
W&SCL

8935
W&SCL

8980
W&SCL

8906
WSCL

8692
WSW
II

8982
WSW
II

8937
WSW
II

8996
WSW
II

8933
WSW
II

8944
WSW
II

8989
WSW
II

8565
BTW

8543
BTW

8893
Sewer Repairer
I

8946
WSW
II

11606
WSW
II

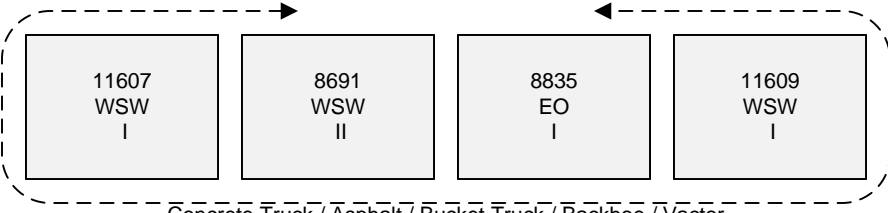

Concrete Truck / Asphalt / Bucket Truck / Backhoe / Vactor

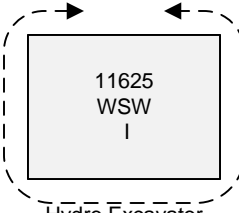

Hydro Excavator

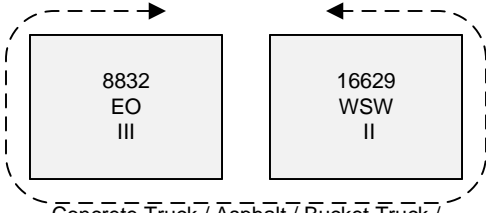

Concrete Truck / Asphalt / Bucket Truck /
Backhoe / Vactor

Sewer Repair / Restoration

Sewer Cleaning

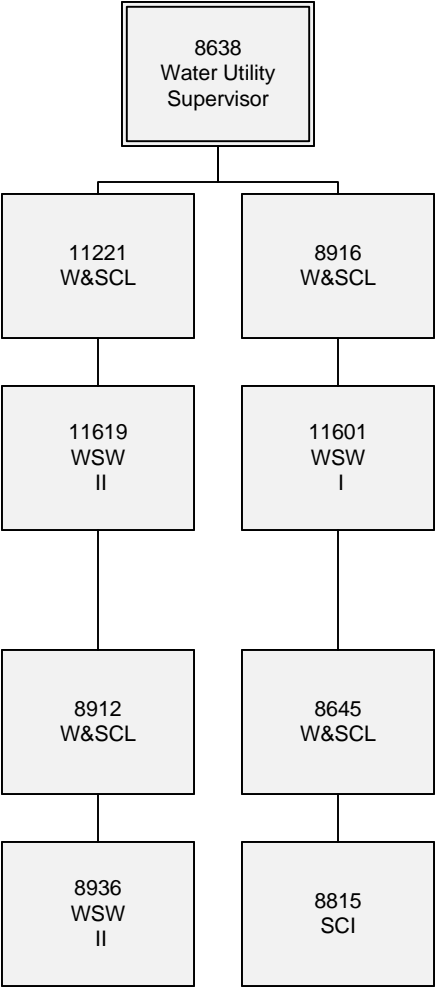

East

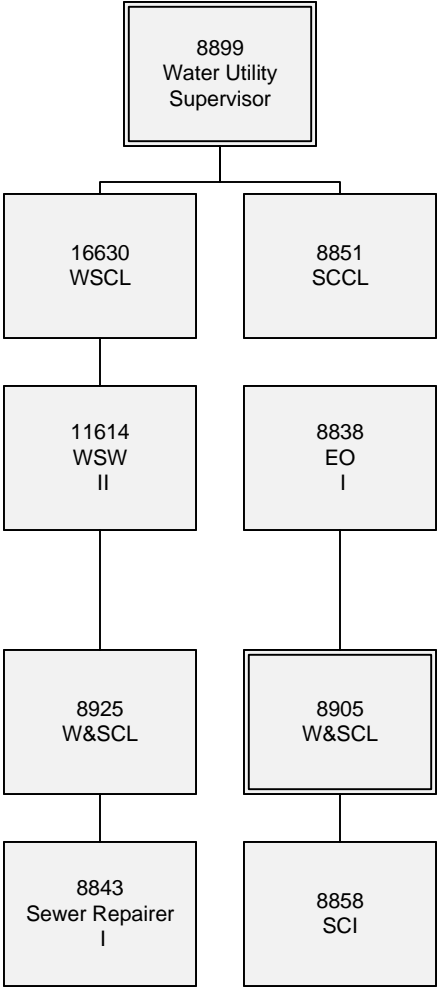
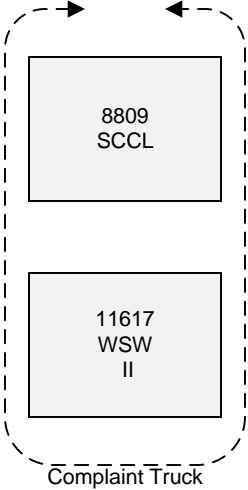

West

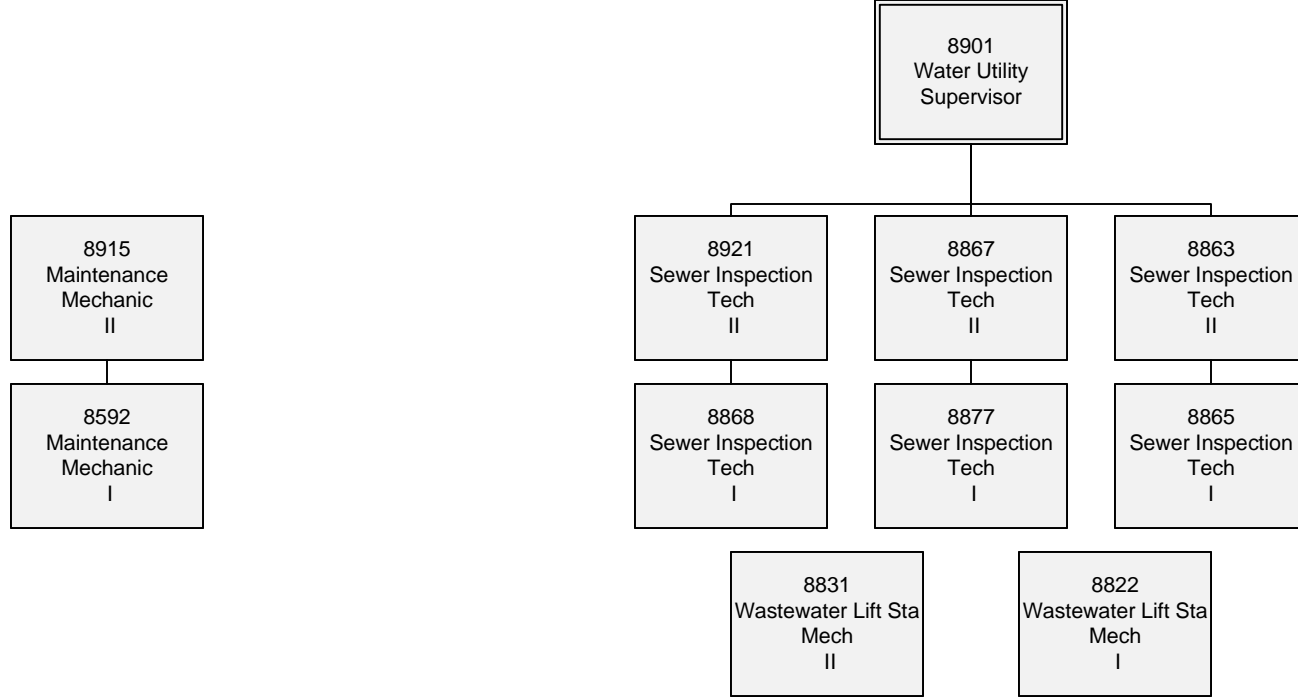

Equipment / Safety / Extra Duty / AVL

CCTV/PS

